

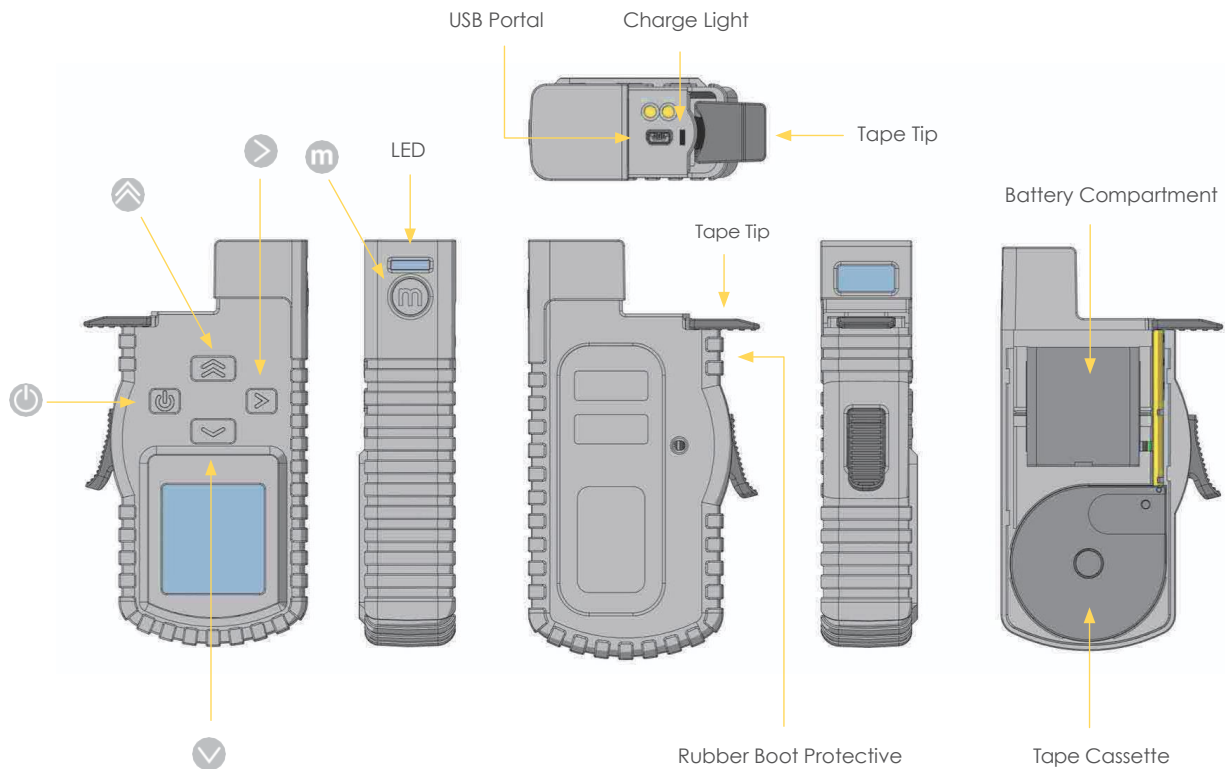







Exterior Overview



-  Press to record measure
-  Send data record
-  Backspace; power on/off
-  Scan barcode
-  Append; save data
- All buttons can be used for navigation under menu mode except for .

Power On/Off



To turn on the device, once press .

To shut down the device, press  for approximately 3 seconds, then release when "power off" is indicated on screen (or 5 beeps are heard).



Insert Pallet

- ▶ While the cursor is in the length field, press  or  to insert the default pallet length and width.

Return to Last Recorded Data

- ▶ Press  several times until the cursor is in the length field;
- ▶ Press  will display the last recorded measurement on screen.

Append

- ▶ The append function enables the operator to sum three measurements of length together, especially when the item length is longer than the 3 meter tape.
- ▶ After measuring length 1, press  to append;
- ▶ Measure length 2 and length 3;
- ▶ Record appended measurement by pressing  or .
- ▶ The length recorded will be the sum of length 1, 2 and length 3.

Battery Charging and Feedback

- ▶ A battery indicator symbol appears at the left bottom of the screen.
- ▶ The symbol displays battery in the form of percentage.
- ▶ To charge the battery, connect Cubetape PRO to a PC or power adaptor via the USB cable.
- ▶ The charge light is on during the charging process.
- ▶ When charging is finished, the charge light will go off.
- ▶ If the battery remaining drops below 10%, the symbol turns red and alerts the operator.

Tape Cassette and Battery Replacement

- ▶ To replace the tape cassette and battery, remove the rubber sleeve first.
- ▶ Slide the rear cover of the device down by pushing the index triangle at the upper right corner of the rear cover as indicated below.
- ▶ Remove and replace the battery by slightly press the trough at the middle edge of the battery upward as indicated below.
- ▶ Remove and replace the tape cassette by turning Cubetape PRO over, extracting the tape a few centimeters and then lifting the tape away from the device slowly.

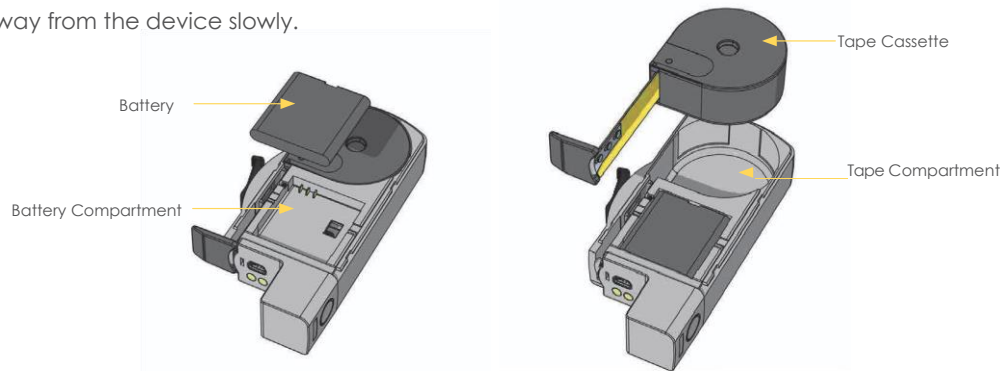

Cleaning and Maintenance Process

- ▶ For sensor versions daily clean the system using the air duster and maintenance port as shown. (Note the maintenance port is concealed beneath the rugged cover.)
- ▶ Regularly wipe the tape blade with a non-solvent cleaner.
- ▶ Replace the tape when tape is worn and yellow particles appear.

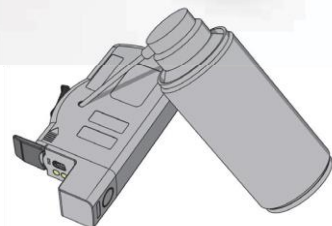

Safety Instruction

- ▶ Caution: Class 2 Laser Product, do not stare into beam.
- ▶ Do not use this device in a hazardous environment.
- ▶ The safety of this device cannot be ensured if it is not operated properly in accordance with the instructions below.
- ▶ Use storage batteries from the manufacturer only.
- ▶ Do not charge the battery in humid or dusty rooms or below 0°C (32°F) ambient temperature.
- ▶ Avoid falling, shaking and other types of strong mechanical impact.

Disposal of Electrical and Electronic Equipment



In conformance with the European Directive 2002/96/EC on Waste Electrical and Electronic Equipment (WEEE) this device may not be disposed of in domestic waste.

This also applies to countries outside the EU, per their specific requirements.

Please dispose of this product in accordance with local regulations at the collecting point specified for electrical and electronic equipment.

If you have any questions, please contact the responsible authority or the distributor from which you purchased this device.

Should this device be passed on to other parties (for private or professional use), the content of this regulation must also be related. Thank you for your contribution to environmental protection.

Service Information

To get more instruction or download the PC software, please contact your certified Cubetape Partner.

